



**AH & MET<sup>®</sup>**

yüzerce ürün  
tek güvence...



1998 yılında kurulan firmamız paket asansör ve ekipmanları satışı yapan, Türkiye'nin önde gelen lider firmalarındandır. Yurt içinde doğu'dan batıya , kuzeyden güney'e geniş bir hizmet yelpazesi oluşturan firmamız , müşterilerinden aldığı güvenle son yıllarda 44 ülkeye ihracat yaparak bu yelpazesini yurtdışında da genişletmiştir.

Türkiye'nin sanayi merkezi Konya'da 20.000 m<sup>2</sup> fabrikamızda , kabin, kontrol sistemleri, yarı ve tam otomatik kapı , süspansiyon ve şase üretmekteyiz. Ürünlerimizi Avrupa Standartları ( CE ) , Rusya Standartları ( EAC ) ve Ukrayna Standartlarına göre üretmekte ve belgelendirmekteyiz. Firmamız yüksek kalite ve zamanında teslimat prensibi ile çalışarak birçok yerli ve yabancı markanın satışını yapmaktadır.

Ülkemizde ve dünyadaki gelişmeleri sürekli takip eden genç ve dinamik kadromuz ile teknolojik gelişimi ve yeniliği hedefleyen firmamız, müşteri odaklı hizmet anlayışı ile geçmişin ışığı altında geleceğe sağlam adımlar atarak sektörde yerini almaya devam edecektir.

Founded in 1998, our company package lifts and equipment is one of Turkey's leading company in sales. By creating a wide service range from East to West and North to South in domestic market our company has extended the range to 44 countries to Thanks to customers trust in recent years.

We produce cabin , control systems , doors , suspension and chassis according to special shaft in 20.000 m<sup>2</sup> place factory in Industry center of Turkey is Konya . All products have certificate European Standard ( CE ) , Russian Standard ( EAC ) and Ukranian Certificate.

Our company is working with high quality and timely delivery principle at the same time too many Domestic and foreign brand products selling. Continuously tracking progress in our country and in the world our company with its young and dynamic staff targeted at technological development and innovations , customers oriented service conception makes firm steps to the future in the light of the past and will continue to be involved in the sector side by side with its clients.

Наша компания была основана 1998 году и занимается производством лифтового оборудования, а так же компонентов к данному оборудованию. Являясь одним из лидеров по производству и продаже в этой отрасли; мы предоставляем качественные услуги как внутри Турецкой Республики, так и более 100 зарубежным фирмам из 44 страны. Завод находится в городе Кonya Турецкой Республики и имеет 20 000 квадратных метров. Производство оснащено последним технологическим парком оборудования и производит такие компоненты как: двери, кабины, станции управления и специальные рамы для шахты. Вся продукция производится строго по европейскому (CE) и евразийскому (EAC) стандарту и владеет сертификатами различных стран. Также Вы можете приобрести у нас качественную продукцию известных Европейских и Турецких марок по приемлемым ценам и своевременной доставкой. Мы динамично развивающаяся фирма с профессиональными квалифицированными кадрами постоянно инновационно-модернизируя свою продукцию уверенно шагаем в перед. Качество, надежность и безопасность продукции - это основной приоритет политики нашей компании.

منذ عام 1998 تعد شركتنا إحدى الشركات التركية الرائدة في مجال بيع المصاعد الكاملة وكامل مستلزماتها . من خلال إنشاء شبكة خدمات واسعة من الشمال إلى الجنوب ومن الشرق إلى الغرب في السوق المحلية ، استطاعت شركتنا أن توسع نطاق خدماتها لتشمل 44 دولة في السنوات الأخيرة ، لتكسب بذلك ثناء وثقة العملاء .

نحن ننتج الكابائن ولوحات التحكم والأبواب الأتوماتيكية والنصف أتوماتيكية والتعليق والشاسيهات ، في مساحة 20.000 متر مربع من مدينة قونيا التي تعد أكبر مركز صناعي في تركيا .

جميع منتجاتنا حائزة على شهادات المواصفات القياسية الأوروبية (CE) والروسية (EAC) والأوكرانية . تعمل شركتنا بمبدأ التصنيع بأعلى مستويات الجودة والتسليم بالوقت المناسب المحدد ، وفي السياق ذاته نبيع منتجات العديد من الماركات المحلية والأجنبية . تلاحق شركتنا ركب التطور والتقدم في بلدنا وفي العالم بموظفيها الشباب وفنييها ومهندسيها ، وتهدف إلى التطوير المستمر والابتكار ، وتخطو خطوات واثقة نحو المستقبل على ضوء تجارب الماضي ، وتواصل تقديم خدماتها المتكاملة في هذا القطاع جنباً إلى جنب عملائها .





# SERTİFİKALAR CERTIFICATES

**TSEK TÜRK STANDARLARI ENSTİTÜSÜ**  
KURUMSAL YÜKSELİM BELGESİ  
**TURKISH STANDARDS INSTITUTION**  
CERTIFICATE OF CONFORMANCE TO CRITERIA

**TSEK** **TS EN ISO 9001:2008**

Management System as per  
**EN ISO 9001:2008**

**AHMET ASANSÖR SAN. VE TİC. LTD. ŞTİ.**  
Büyükdere Mah. T. Ziyaeddin Akbulut Cad. No:16 Beşiktaş  
422 50 KONYA, TÜRKİYE

**TÜV AUSTRIA**

**TSEK TÜRK STANDARLARI ENSTİTÜSÜ**  
KURUMSAL YÜKSELİM BELGESİ  
**TURKISH STANDARDS INSTITUTION**  
CERTIFICATE OF CONFORMANCE TO CRITERIA

**TSEK** **TS EN ISO 9001:2008**

Management System as per  
**EN ISO 9001:2008**

**AHMET ASANSÖR SAN. VE TİC. LTD. ŞTİ.**  
Büyükdere Mah. T. Ziyaeddin Akbulut Cad. No:16 Beşiktaş  
422 50 KONYA, TÜRKİYE

**TÜV AUSTRIA**

**CERTIFICATE** **TÜV AUSTRIA**

Management System as per  
**EN ISO 9001:2008**

**AHMET ASANSÖR SAN. VE TİC. LTD. ŞTİ.**  
Büyükdere Mah. T. Ziyaeddin Akbulut Cad. No:16 Beşiktaş  
422 50 KONYA, TÜRKİYE

**TÜV AUSTRIA**

**SERTİFİKA** **TÜV AUSTRIA**

Management System as per  
**EN ISO 9001:2008**

**AHMET ASANSÖR SAN. VE TİC. LTD. ŞTİ.**  
Büyükdere Mah. T. Ziyaeddin Akbulut Cad. No:16 Beşiktaş  
422 50 KONYA, TÜRKİYE

**TÜV AUSTRIA**

**000** **CEPİT**

**CEPİT BELGESİ**

**AHMET ASANSÖR SAN. VE TİC. LTD. ŞTİ.**  
Büyükdere Mah. T. Ziyaeddin Akbulut Cad. No:16 Beşiktaş / Konya/Türkiye

**TÜV AUSTRIA**

**EN ISO 9001** **AH & MET**

Management System as per  
**EN ISO 9001:2008**

**AHMET ASANSÖR SAN. VE TİC. LTD. ŞTİ.**  
Büyükdere Mah. T. Ziyaeddin Akbulut Cad. No:16 Beşiktaş / Konya/Türkiye

**TÜV AUSTRIA**

**EREC** **СЕРТИФИКАТ**

**EREC** **СЕРТИФИКАТ**

**AHMET ASANSÖR SAN. VE TİC. LTD. ŞTİ.**  
Büyükdere Mah. T. Ziyaeddin Akbulut Cad. No:16 Beşiktaş / Konya/Türkiye

**TÜV AUSTRIA**

**EREC** **СЕРТИФИКАТ**

**EREC** **СЕРТИФИКАТ**

**AHMET ASANSÖR SAN. VE TİC. LTD. ŞTİ.**  
Büyükdere Mah. T. Ziyaeddin Akbulut Cad. No:16 Beşiktaş / Konya/Türkiye

**TÜV AUSTRIA**

**Sr** **AT UYGUNLUK SERTİFİKASI**

Asansör Kat Kapıların Yangına Dayanımı

**AH-MET ASANSÖR SAN. VE TİC. LTD. ŞTİ.**

**SZUTEST**

**Sr** **EC CERTIFICATE**

Fire Resistance of Lift Landing Doors

**AH-MET ASANSÖR SAN. VE TİC. LTD. ŞTİ.**

**SZUTEST**

**Sr** **AT UYGUNLUK SERTİFİKASI**

Asansör Kat Kapıların Yangına Dayanımı

**AH-MET ASANSÖR SAN. VE TİC. LTD. ŞTİ.**

**SZUTEST**

**Sr** **AT UYGUNLUK SERTİFİKASI**

Asansör Kat Kapıların Yangına Dayanımı

**AH-MET ASANSÖR SAN. VE TİC. LTD. ŞTİ.**

**SZUTEST**

**Sr** **AT UYGUNLUK SERTİFİKASI**

Asansör Kat Kapıların Yangına Dayanımı

**AH-MET ASANSÖR SAN. VE TİC. LTD. ŞTİ.**

**SZUTEST**

**Sr** **EC CERTIFICATE**

Fire Resistance of Lift Landing Doors

**AH-MET ASANSÖR SAN. VE TİC. LTD. ŞTİ.**

**SZUTEST**



**FUARLAR  
FAIRS**

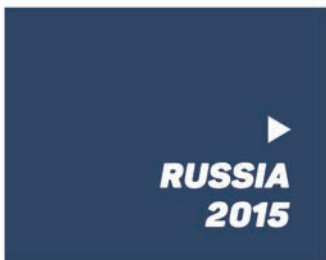
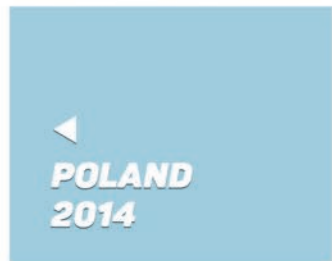
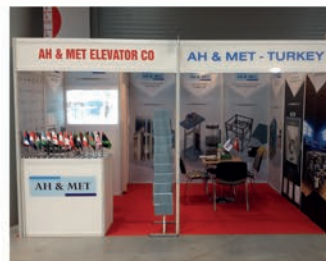
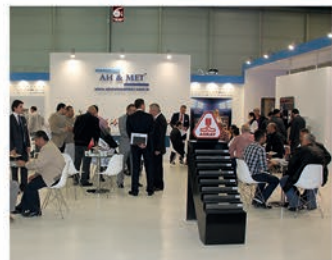
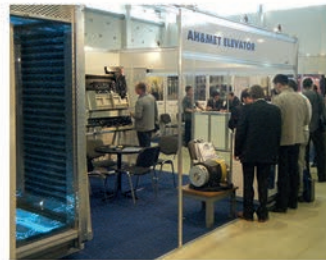
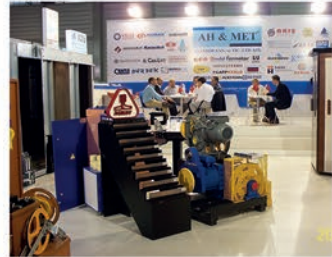



***KABİNLER***  
***CABINS***



## ÖZELLİKLER

- Duvarlar 1,5 mm galvanizli sac
- Laminant kabinler 18 mm radüslü
- Paslanmaz kabinler 304 kalite
- Komple lazer tavan
- Cam kabinlerde farklı renk ve desen uygulamaları
- Cam ve led tavan seçeneği
- PVC anti bakteriyel taban
- 20 mm doğal granit taban seçeneği
- Farklı taban seçenekleri
- Çalıştırılmaya hazır aydınlatma ve fan
- Titreşimi önleyen özel bükümler ve takozlar
- Tercihe bağlı sandık ambalaj

## المواصفات

- الجدار 1.5 مم من الألواح الحديدية.
- الكبائن الخشبية الخشب بسماعة 18 مم .
- الكبائن الستانلس ستيل بجودة 304 .
- السقفيات قص ليزر .
- تنفيذ زجاج الكبينة بمختلف الألوان والتصاميم .
- خيارات متعددة للزجاج وإضاءة الأسقف .
- الأرضية PVC مضادة للبكتيريا .
- خيارات الأرضية من الغرانيت الطبيعي بسماعة 20 مم .
- خيارات متنوعة من الأرضيات .
- الإضاءة والمروحة مجهزة للتشغيل .
- قواعد التثبيت خاصة لمنع الاهتزاز .
- التغليف حسب الرغبة .
- المكابح موجودة في كل كبائننا .

## FEATURES

- 1,5 mm Galvanized Sheet Walls
- 18 mm Radius Laminate Cars
- Stainless Steel Cars of 304 Quality
- Complete Laser Ceiling
- Various Color and Pattern Options for Glass Cars
- Range of Glass and LED Ceilings
- Antibacterial PVC Floor
- Range of 20mm Natural Granite Floors
- Range of Various Floors
- Lighting and Fan Ready for Operation
- Special Bends and Wedges for Vibration Preventing
- Optional Case Packing

## ОСОБЕННОСТИ

- Толщина оцинкованного листа кабины 1,5 мм
- Толщина стен кабины 18 мм
- Кабины из нержавеющей стали 304 качества
- Энергосберегающий светодиодный потолок
- Возможность выбора различных цветов и узоров для стеклянных кабин
- Возможность выбора различного дизайна светодиодных потолков
- Антибактериальные и износостойкие ПВХ-покрытия для пола
- Возможность выбора натуральных гранитных полов толщиной 20мм
- Возможность выбора различного дизайна для полового покрытия
- Вентиляция кабины
- Специальные гасители для предотвращения вибрации
- Упаковка оборудования для транспортировки на выбор клиента
- Прогрессивный механизм безопасности – наш стандарт во всех кабинах.



**KABINLER**  
CABINS

**BELEN**



**KAPADOKYA**



**GILAN**



**BERCESTE**





NARİN

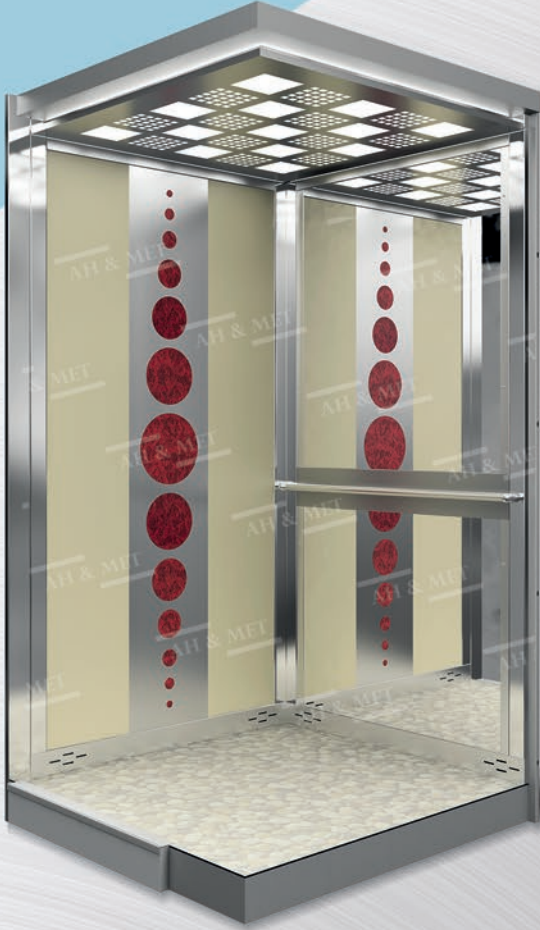

KÜRRE



FUTURE

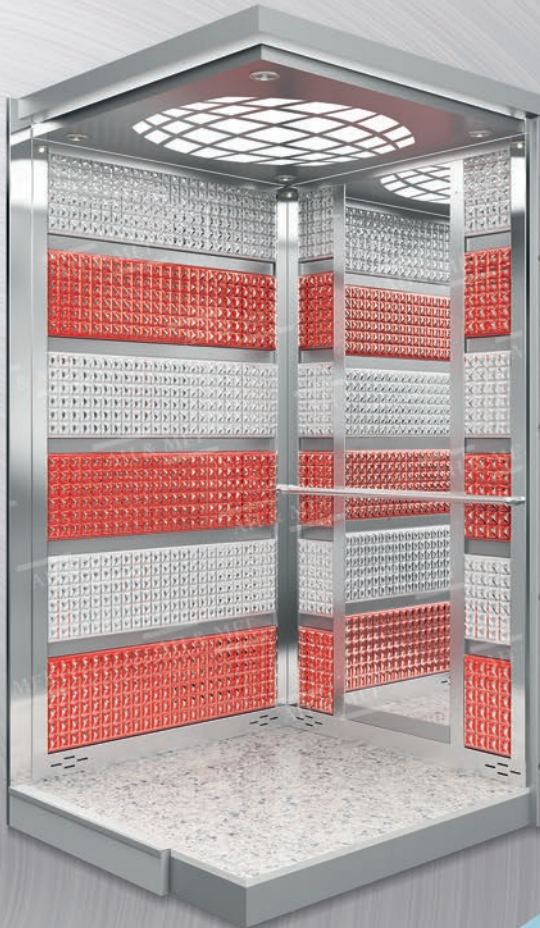

DIDAR





**KABINLER**  
CABINS



**DORU**



**SAHRA**



**SENTE**



**VERONA**



SAFRAN



REDİF



ZEBRA



MOZART





**KABINLER**  
CABINS

**TILSIM**



**SİMA**



**LİRİK**



**VADİ**



**SÖRF**



**BELKIS**



**ORKIDE**



**MANSURE**





**KABINLER**  
CABINS

**RUBAI**



**SEMAI**



**ELDORA**



**FORTUNA**



MANAS



REAL



DIZÖR



KRAFT





**KABINLER**  
CABINS

**BİLLUR**



**KRISTAL**



**CEVHER**



**ZEN**





ELMİNA



TASVİR



HAWAİ



OCEAN





**KABINLER  
CABINS**

**GARDEN**



**SUNLIGHT**



**TOROS**



**DOLPHIN**



**MENEKŞE**



**DELTA**



**ZAMİR**



**RUYET**





**KABINLER**  
CABINS

**ALMİNA**



**ZÜMRÜT**



**SERENCAM**



**TURKUVAZ**



PENTA



HÜRREM

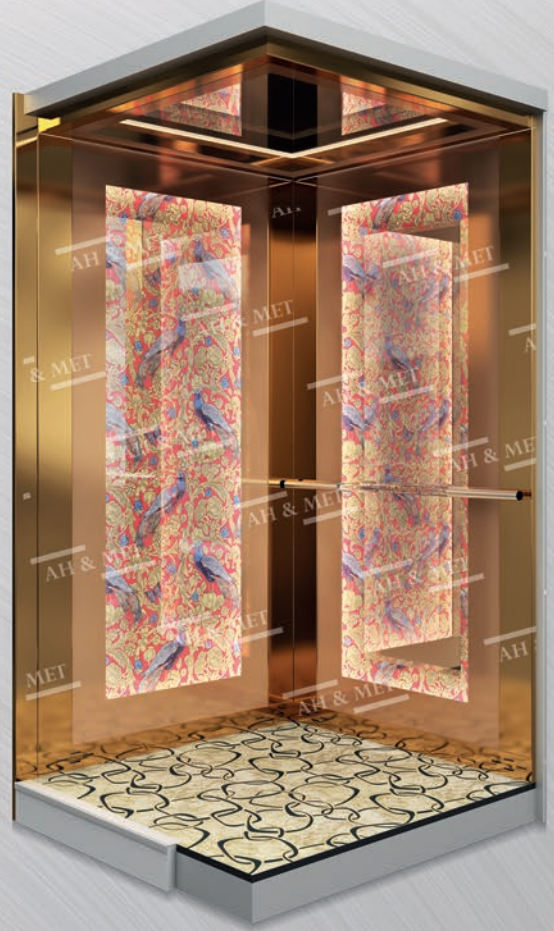

SELÇUKLU



OSMANLI





**KABİNLER**  
CABINS

**EBRULİ**



**BAROK**



**ŞAHESTE**



**GÜLDESTE**



TROPIC



GREEN



AKAY



TUAL





**KABİNLER**  
**CABINS**

## PANORAMİK

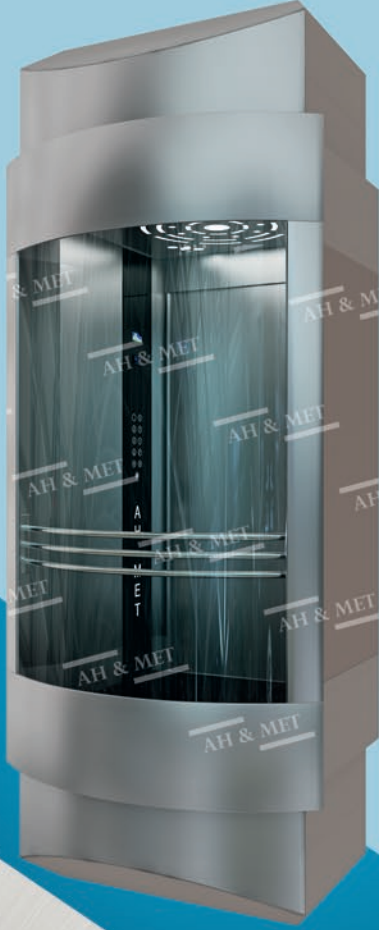

## SAFİR



## SEDYE







**OTOMATİK KAPILAR**  
**AUTOMATIC DOORS**



# OTOMATİK KAPILAR AUTOMATIC DOORS

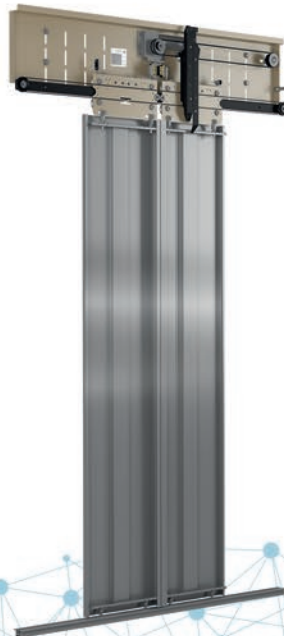
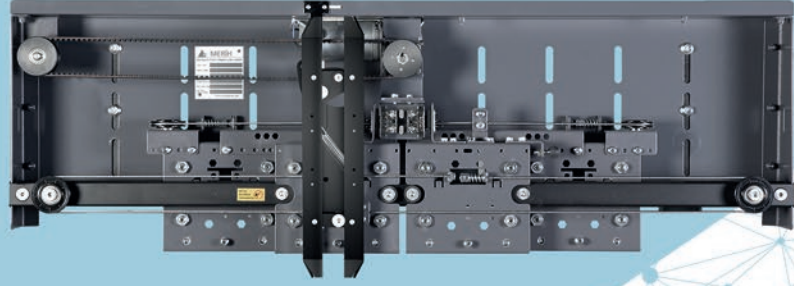
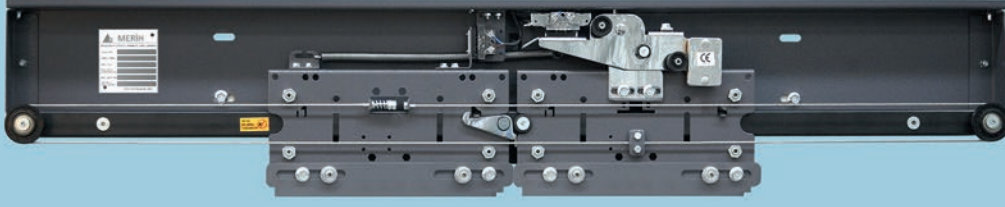

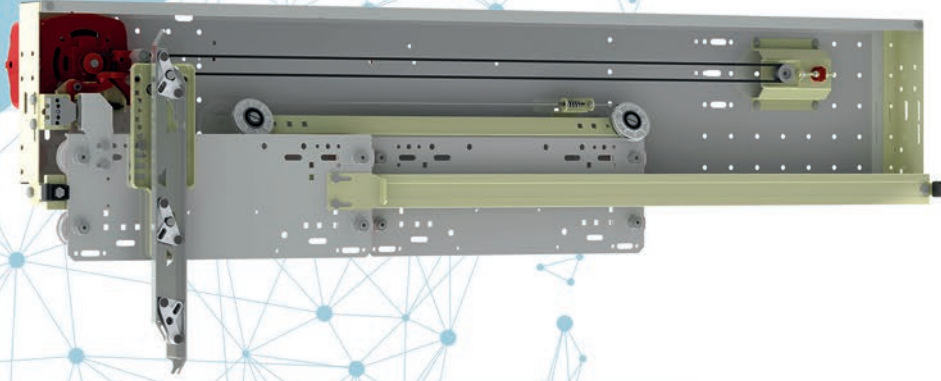

**Fermentor**  
AUTOMATIC DOORS FOR LIFTS

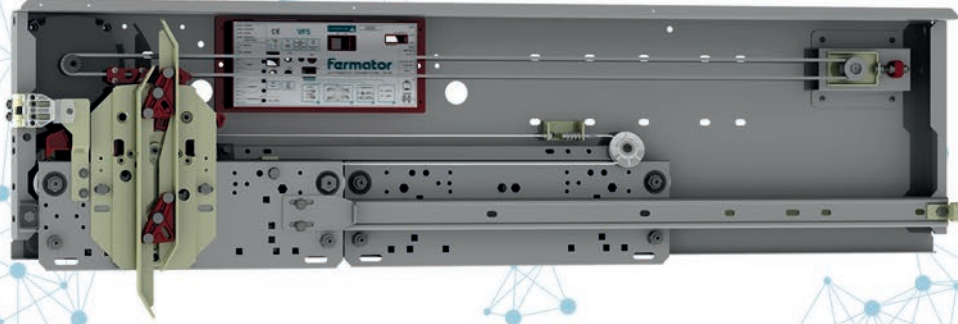



**OTOMATİK KAPILAR**  
AUTOMATIC DOORS

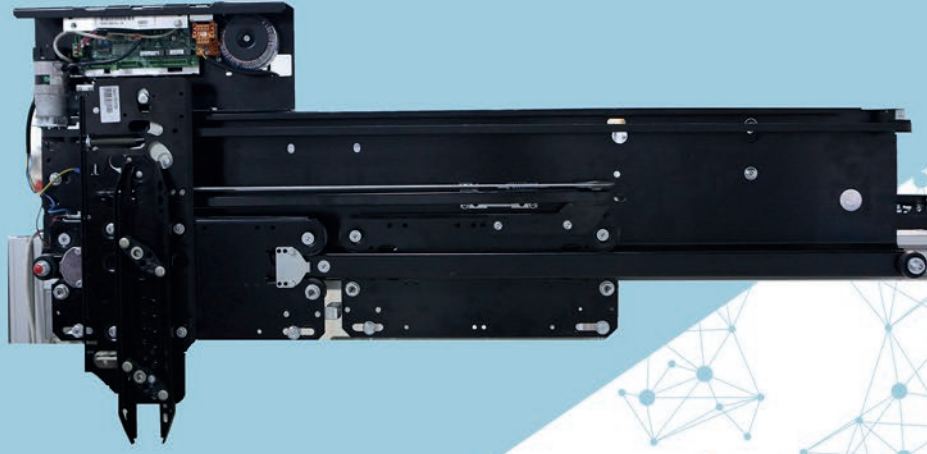

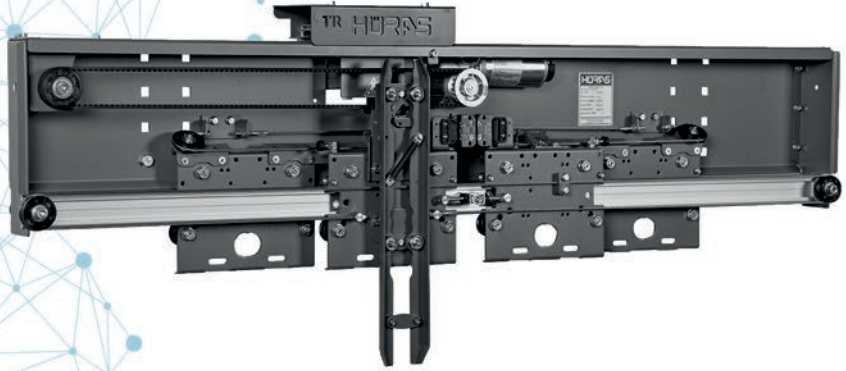
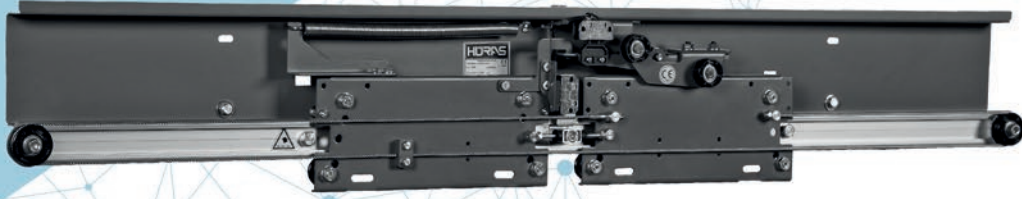



**KAPILAR  
DOORS**





A-4250



A-4251

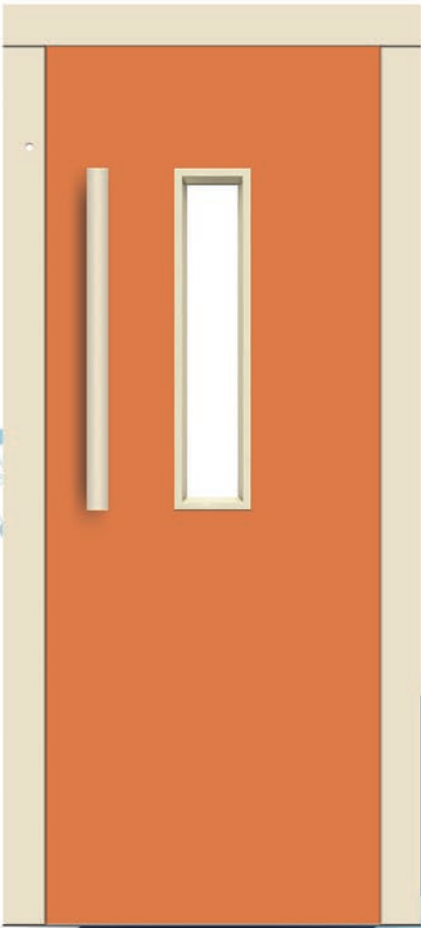

A-4252

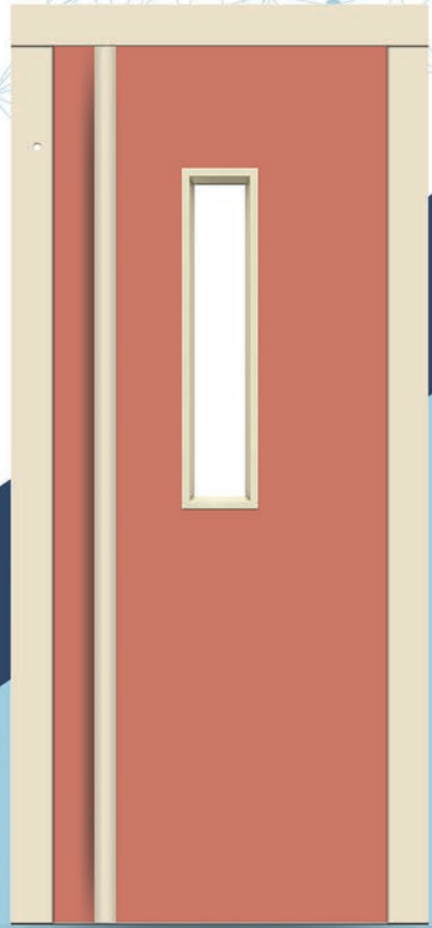

A-4253



**A-4254**

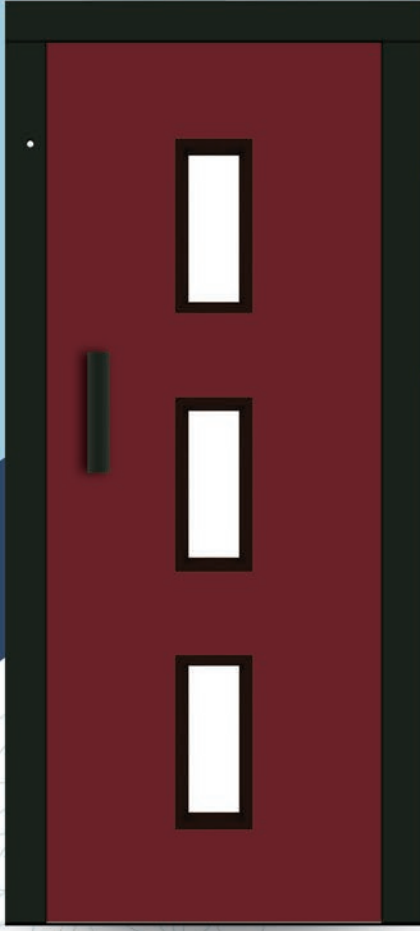

**A-4255**

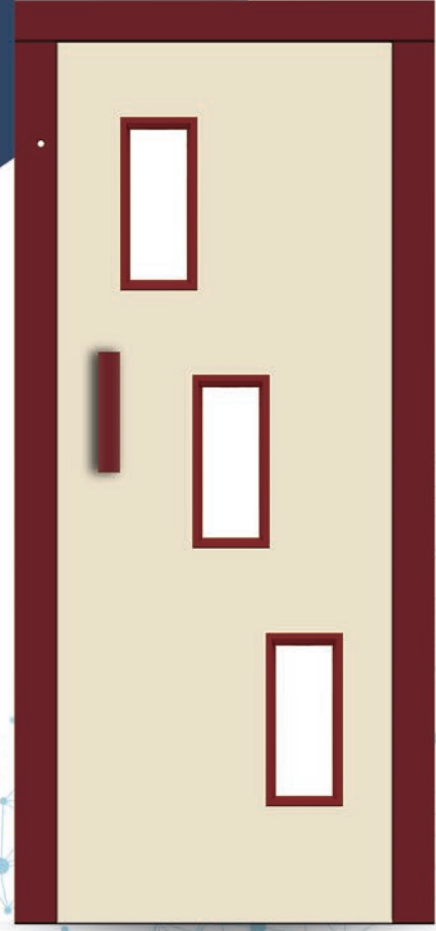

**A-4256**

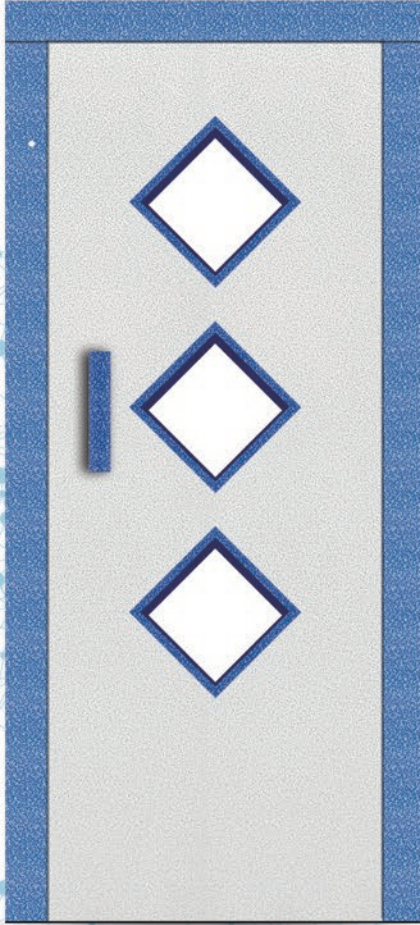

**A-4258**





A-4260

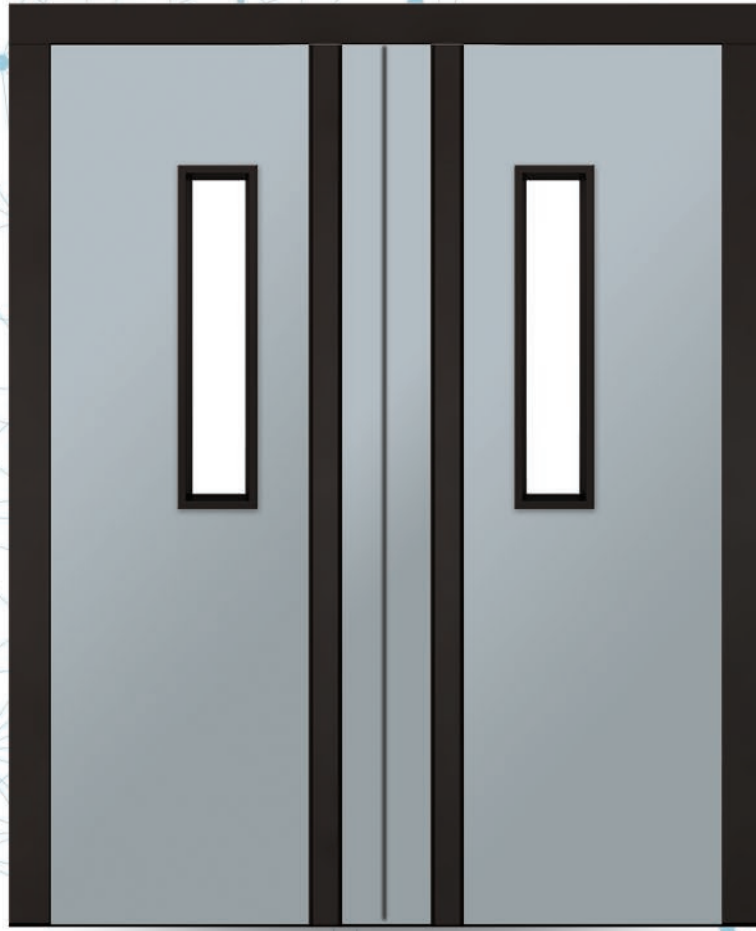

A-4261





**KAPILAR  
DOORS**

**A-4262**

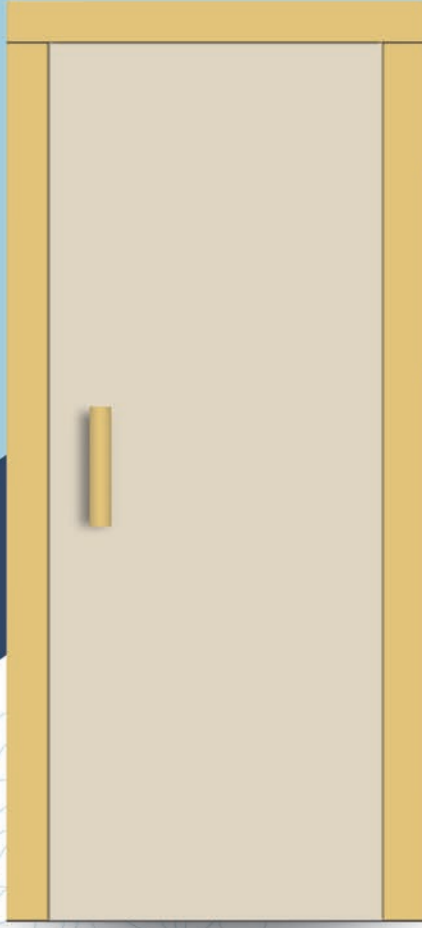

**A-4263**



**A-4264**

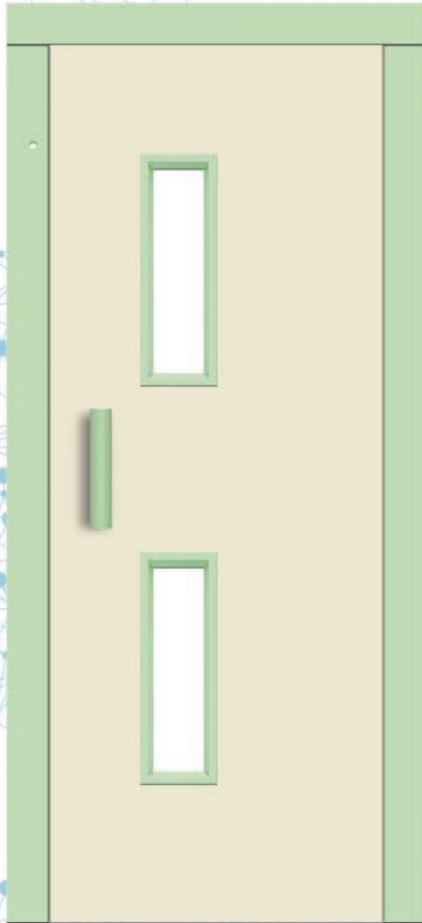

**A-4265**

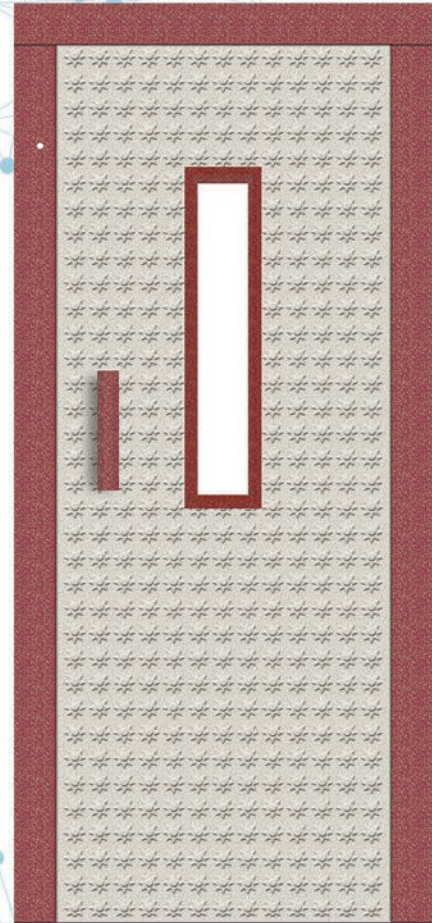

A-4266

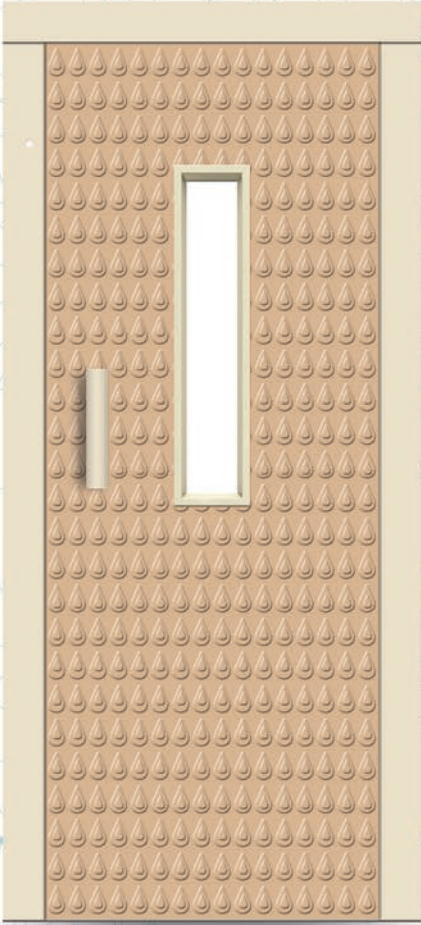

A-4267

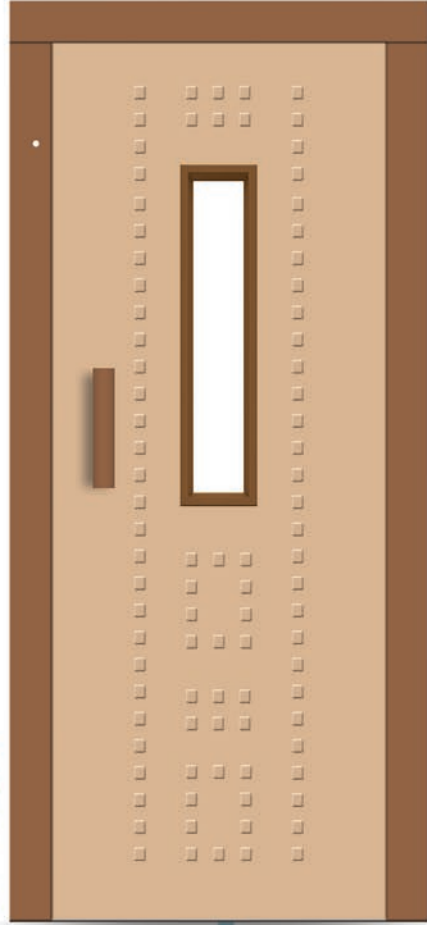

A-4268

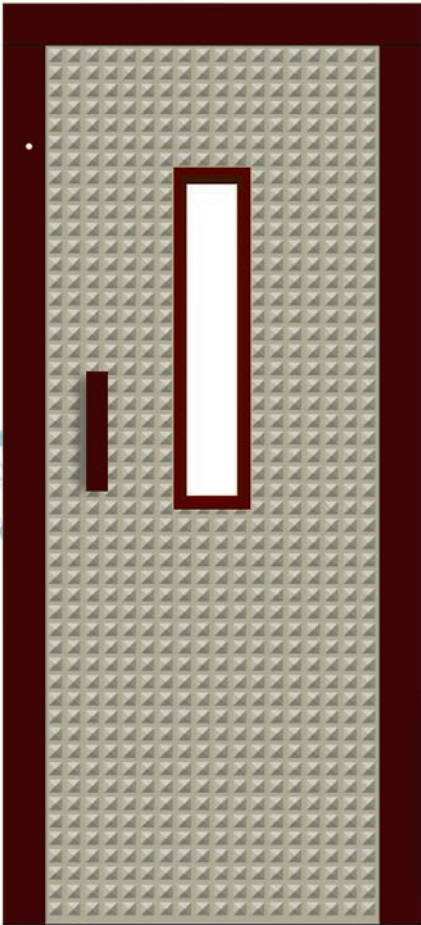

A-4269

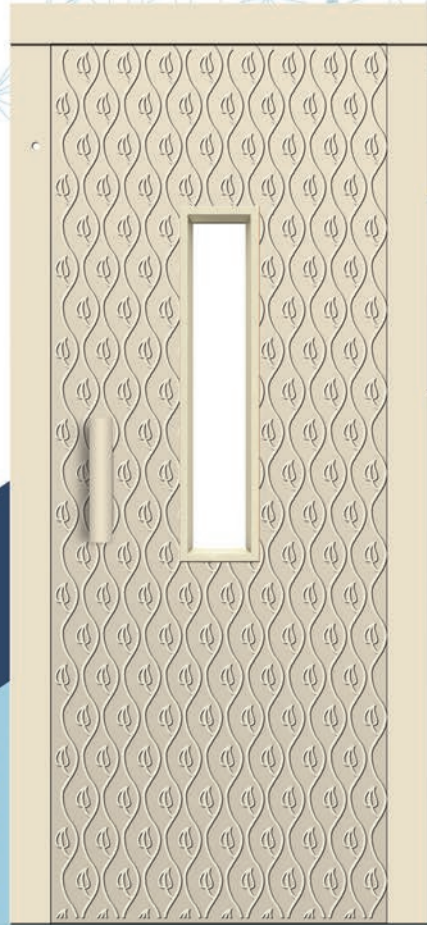



**KAPILAR  
DOORS**

**A-4270**

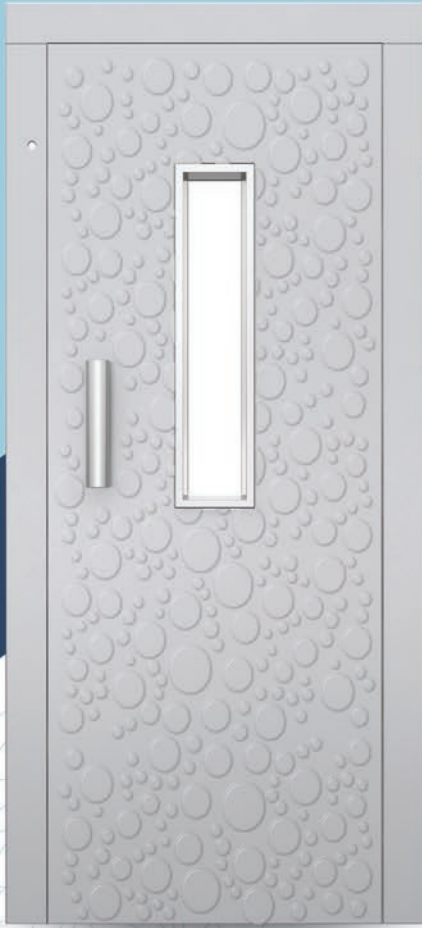

**A-4271**



**A-4272**

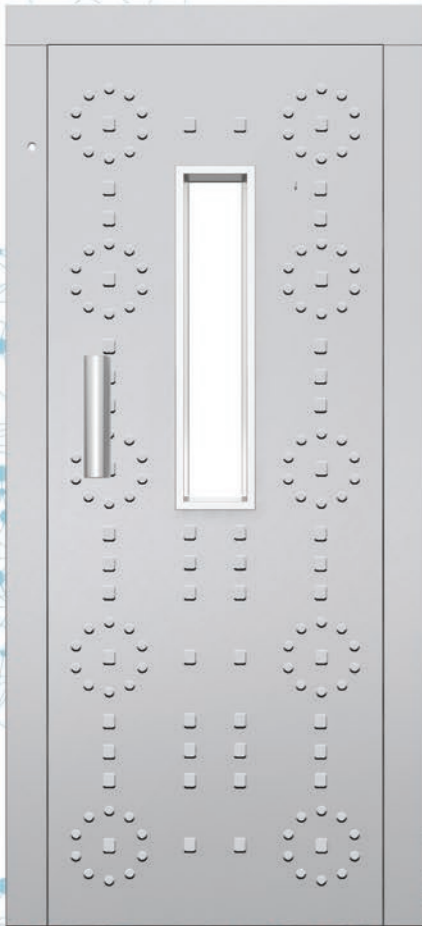

**A-4257**





**SISTEMLER  
SYSTEMS**

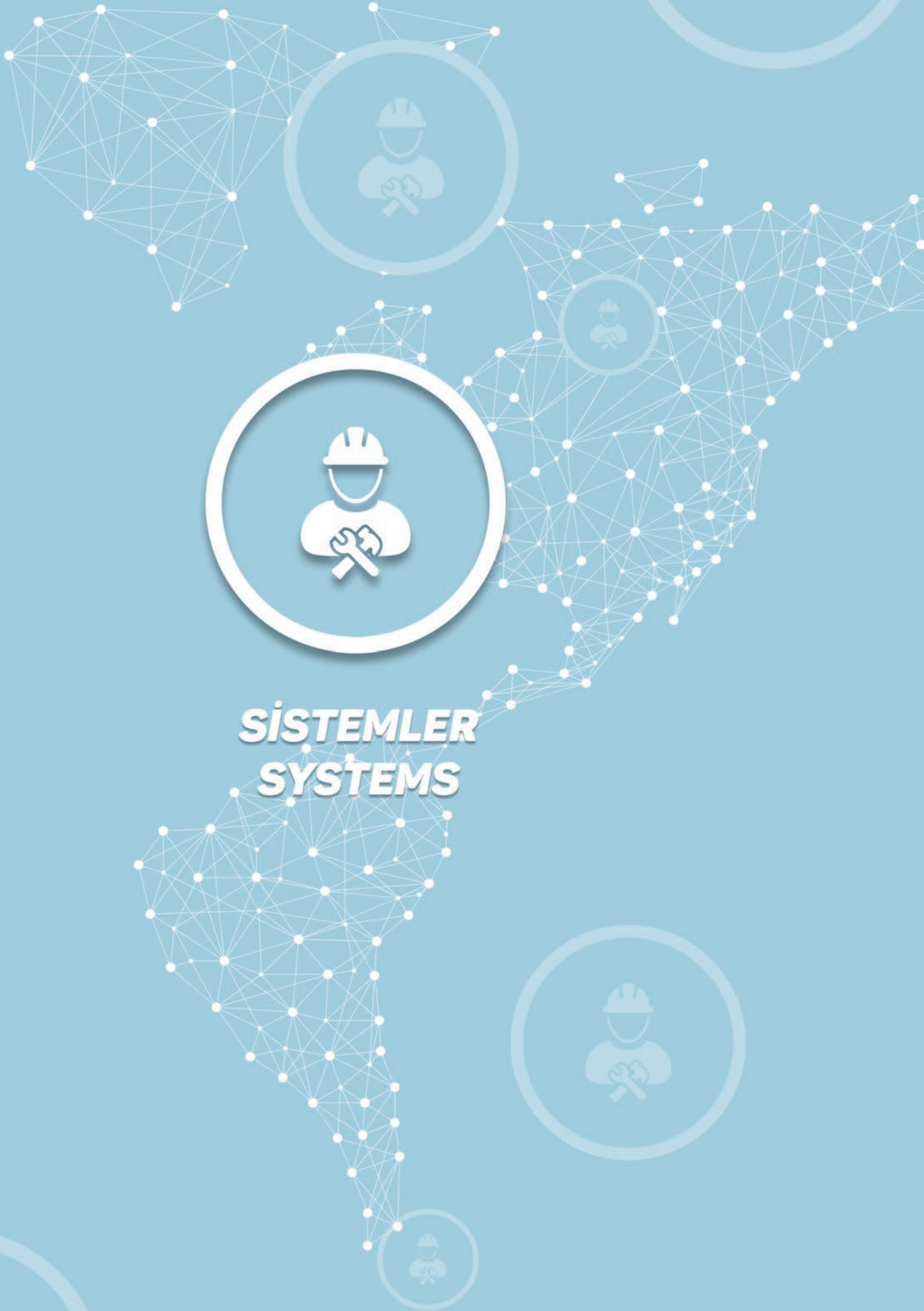

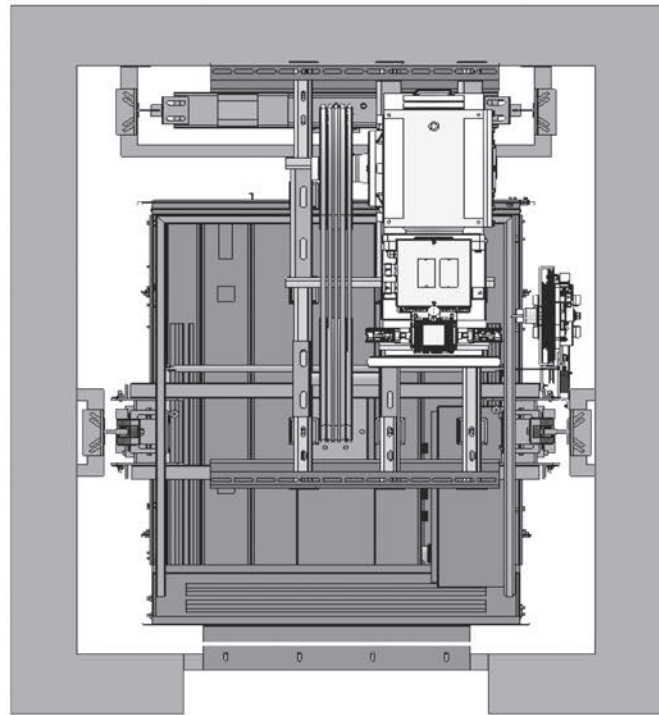
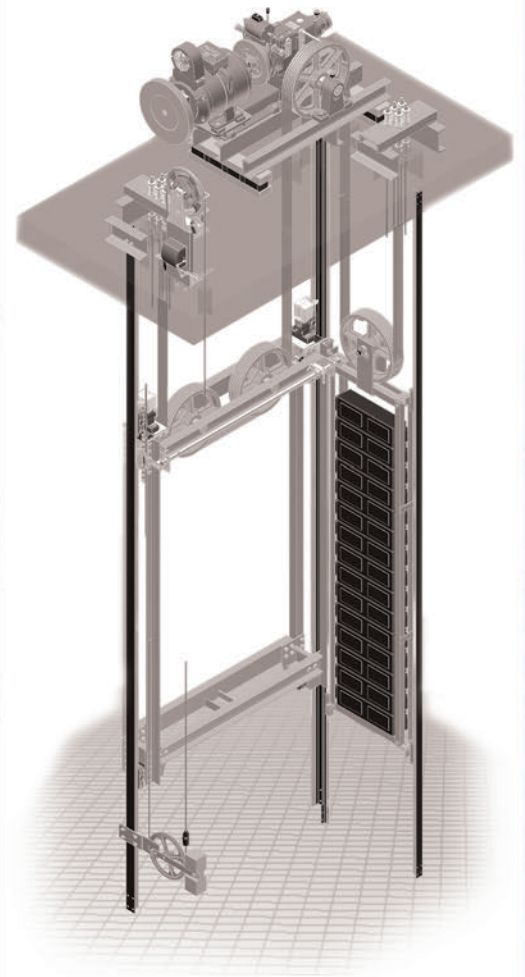
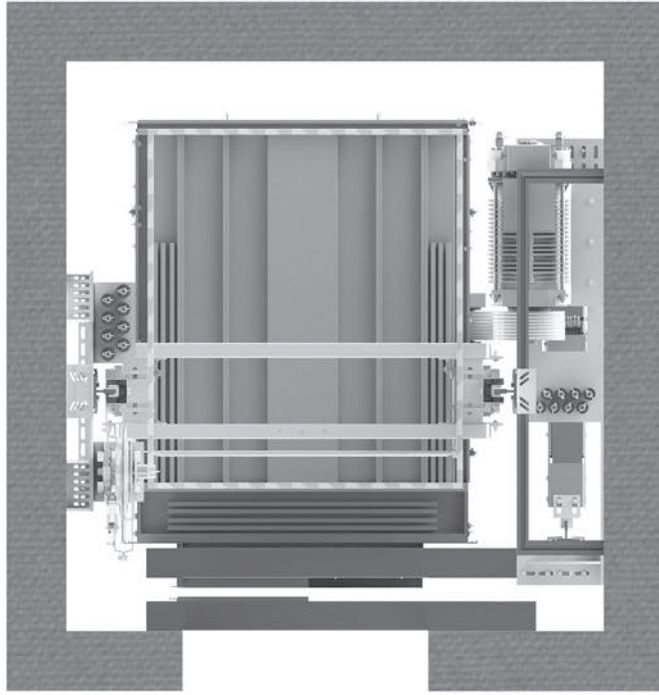

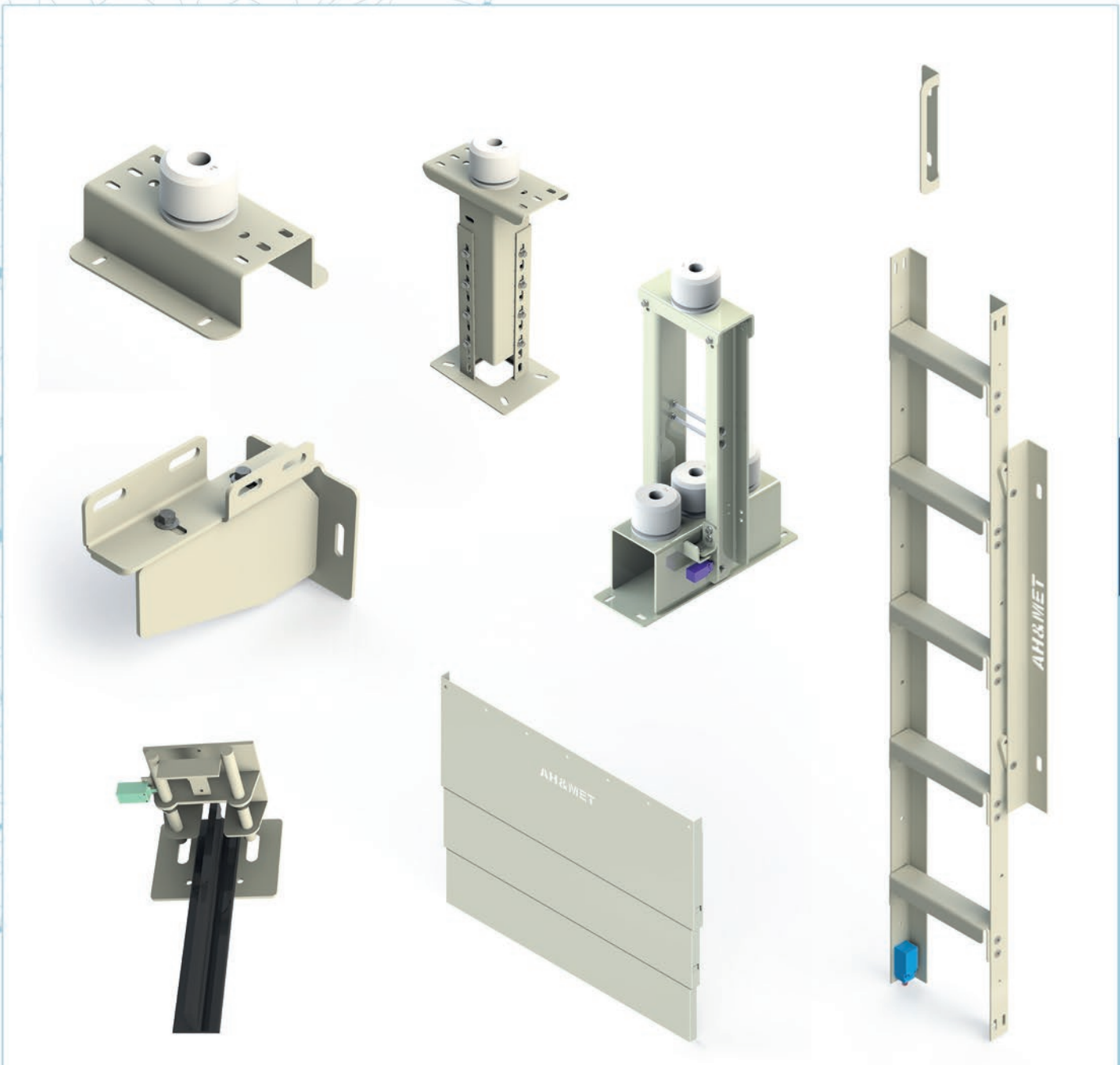

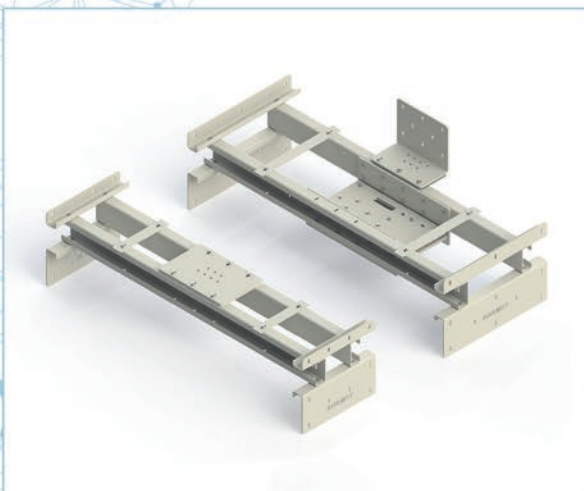
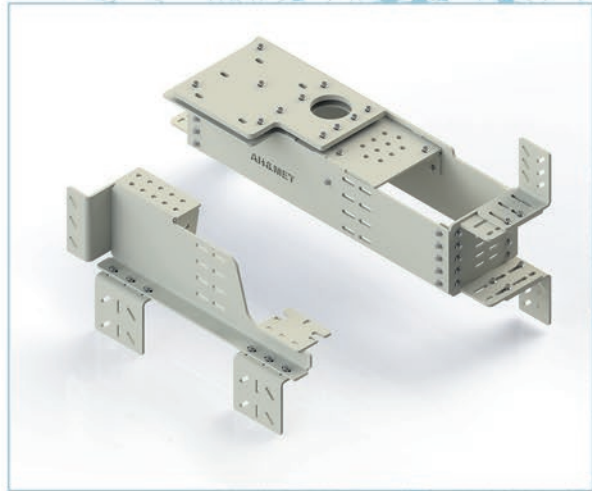
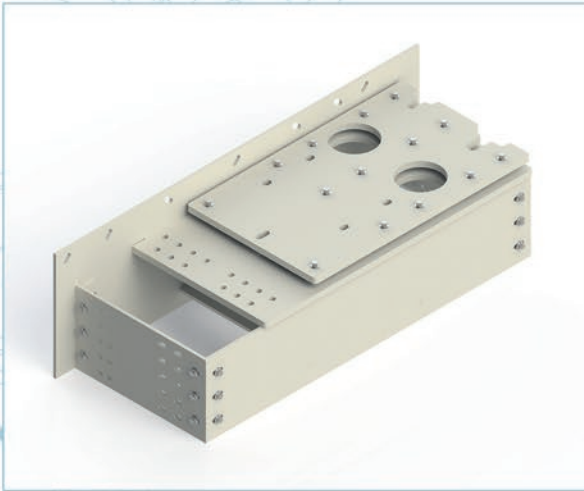
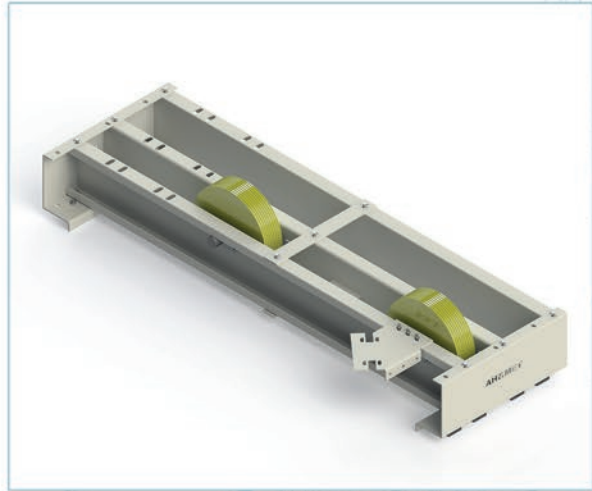
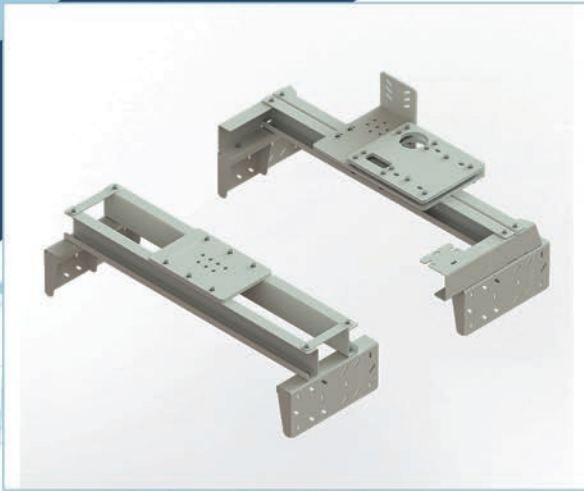
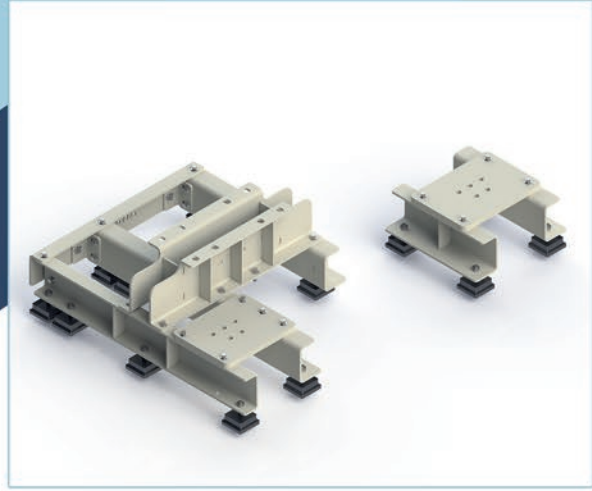
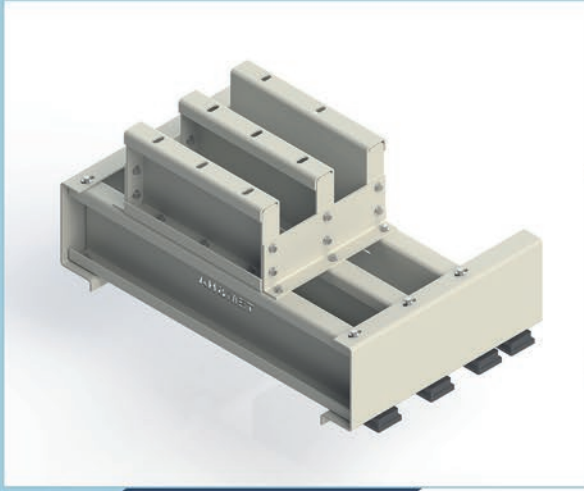





**BUTONLAR**  
**BUTTONS**

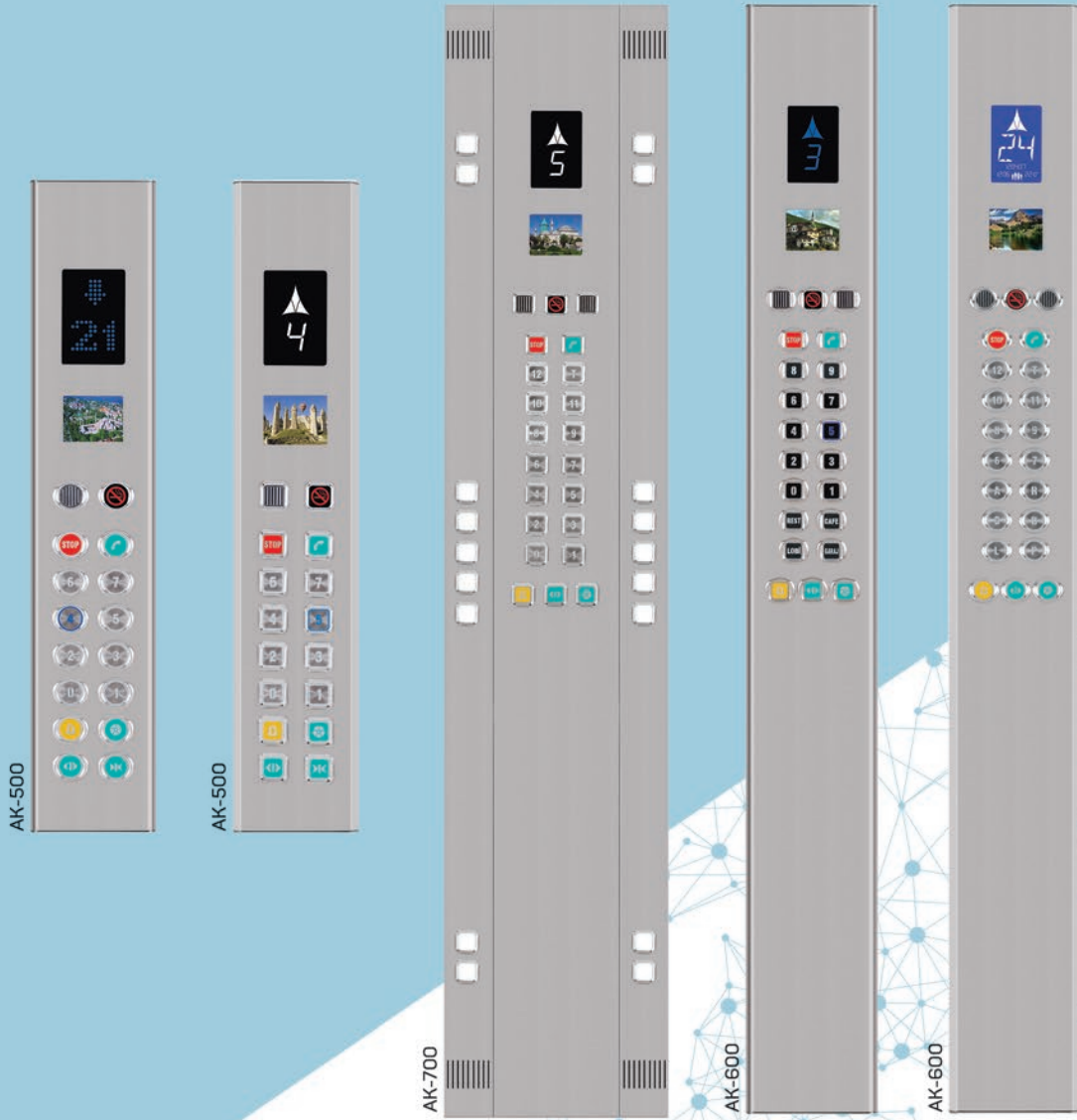

AK-300 M



AK-300 KD



AK 100

AK 110

AK 150 BD

AK 150

AK 160 K

AK 210 BD

AK 215



GIA250 - LCD - 2



GI100



LSPNY 1000



# BUTONLAR BUTTONS



SLIM LINE TEK BUTON



SLIM LINE ÇİFT BUTON



7001 DM



SIVA ÜSTÜ (Y.B.)



SIVA ALTI (Y.B.)



EPISODE



DSC 04707 (YAPRAK KUTULU) SIVA ALTI (T.B.)



U BÜKÜM SIVA ALTI (T.B.)



7105 F6



7115 F6



7205 DM B3



FLX 505 DM B3



510 F6

**BUT - SAN**

Lift Fixtures

**ametal**  
asansör malzemesi



IP 600 M 502



SADE 502



P90 502 QD



BS 2000



COP 2120



BS 200



COP 1120

PANO

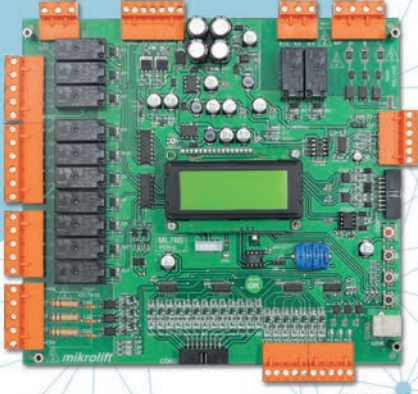

ML70S

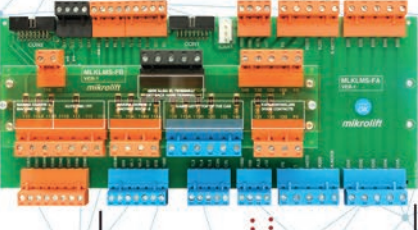

MLKLMS-FB

REVİZYON KUTUSU

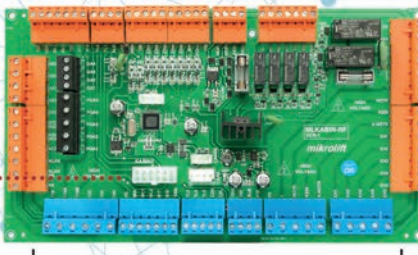

MLKABİN-RF

KABİN



MLKABİN-K



MLTFT

ASANSÖR KONTROL KARTI

- Tam seri iletişim
- Kabin butonunda hassas kabin seviye ayarı
- EN81-1/2 + A3 standartlarına uygunluk
- 32 durak
- Detaylı arıza takibi (saat,tarih)
- Çift otomatik kapı desteği
- Kuyu kopyalama

LIFT CONTROLLER CARD

- Full serial communication
- Sensitive car level setting from the car buttons
- 32 floors
- Detailed fault tracking (hour,date)
- Double automatic door support
- Shaft learning

Seri tesisatta uygun fiyata yüksek performans, hatasız bağlantı, zamandan ve işçilikten tasarruf avantajı...

In serial wiring, high performance with affordable, connection without fault, save time and labor benefits from...

MLKAT-D4M



MLKAT-DS





**BUTONLAR**  
BUTTONS



B 540



B 520



B 500



B 505



B 570



B 555



B 550



B 660



B 590



B 235



B 411



B 305



B 200



B 240



B 210



B 300



**MAKİNE MOTORLAR**  
**MACHINE MOTORS**



AKIŞ



AKIŞ



AKIŞ



AKIŞ



AKAR



AKAR



AKAR



ASTES



EKER

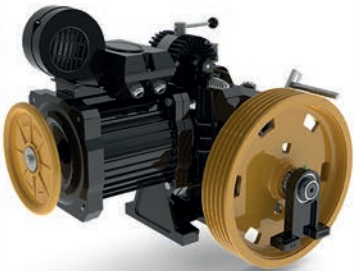

ARK

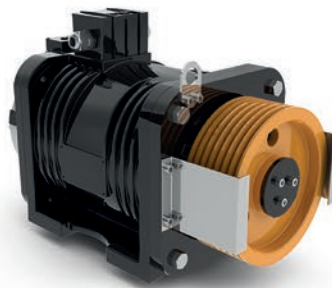

ARK



CLINDAS





ALBERTO SASSI



ALBERTO SASSI



SCHINDLER



MONTANARI



MONTANARI



SICOR



WITTUR



WITTUR



GEM



ÖZBEK

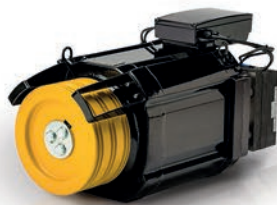

LAFERT



KARASAKAL



***KUMANDA PANOLARI  
CONTROL PANELS***

## ÖZELLİKLER

- Yüksek kalite ve güvenlik
- Çift hızlı, VVVF hız kontrollü, Makine dairesiz, Hidrolik
- Kurtaran ve UPS seçenekleri
- Mikrolift , Arkel , Hedefsan kart seçenekleri
- SCHNEIDER , LG , ABB kontaktör sistemi
- 32 Durağa kadar ayarlanabilir
- 60 adet saat ve tarihli hata hafızası
- Alarm çıkışı
- Seri tesisat
- Seri haberleşme
- Elektrostatik kasa
- Tam otomatik çift kapı çalıştırma özelliği
- Deprem ve yangın sensörü girişleri
- Güvenlik devresinde kaçak akım rölesi
- Ayarlanabilir park durağı
- Karton ambalaj ile taşıma güvenliği
- Tüm panolarımıza bi-stabil ve mıknatıs dahildir
- Fleksibil kablo bağlantı noktası
- Elektrik kesintilerinde kabin içi acil aydınlatma sistemi
- Şifre korumalı programlama, izinsiz kullanıma karşı PUK kodu
- Sesli ikaz sistemi

## FEATURES

- High quality and safety
- Two Speed, VVVF speed control, Roomless, Hydraulic
- Mikrolift , Arkel , Hedefsan quality of cards
- SCHNEIDER , LG , ABB contactor system
- Adjustable up to 32 stops
- 60 errors memory with time and date
- Serial installation
- Alarm exit
- Adjustable park stop
- Serial Communication
- Electrostatic case
- Full automatic double door operation feature
- Earthquake and fire sensor input
- Residual voltage in security circuit
- Wide range of emergency rescue systems and UPS
- Transportation security with carton packing
- All panels include bi-stable and magnet
- Flexible cable connection point
- In-cabin lighting system in case of power cut
- Password protection program, PUK code against unauthorized use
- Voice warning system

## ОСОБЕННОСТИ

- Высокое качество и безопасность
- Двухскоростной, VVVF-контроль скорости, Без машинного помещения, Гидравлический
- Широкий выбор аварийно-спасательных систем и UPS
- Выбор платы системы управления, различных фирм: MIKROLIFT, ARKEL, HEDEFSAN
- Выбор системы контакторов LG, ABB, SCHNEIDER
- Регулируется до 32 остановок
- Память на 60 ошибок с датой и временем
- Аварийный выход
- Серийная установка
- Последовательная связь
- Система звукового сигнала предупреждения
- Полная автоматизация двойных дверей
- Выход для датчика сенсора при землетрясениях и пожаре
- Бесперебойное напряжение в схеме защиты
- Регулируемая остановка кабины
- Электростатическая коробка
- Прочная упаковка для безопасной транспортировки
- Все панели оснащены датчиком точной остановки лифта
- Точка подключения подвешенного кабеля
- Аварийная система освещения кабин в случае перебоя электропитания
- Программа системы управления защищена паролем, а так же PUK-код против несанкционированного использования

## المواصفات

- إمكانية قفل البرنامج بكود PUK لمنع الاستخدام الغير مرغوب
- التركيب التسلسلي .
- الاتصال التسلسلي .
- ميزات تشغيل المصعد ثنائي الباب الأتوماتيكي .
- مدخل لحساس الحريق والمفرزات الأرضية (سينسور) .
- تتبع تسريب التيار في دورة الحماية .
- إمكانية ضبط توقف المصعد (تجريش) .
- الصندوق مطلي بطلاء استاتيكي .
- تأمين توصيل المعدات أثناء النقل بالتغليف الكرتوني .
- المغناطيس و stable-bi موجود في كل لوحاتنا .
- نقطة ربط الكابلات المرنة
- نظام إضاءة داخل الكابينة عند انقطاع التيار الكهربائي .
- خروج الإنذار
- نظام التحذير الصوتي .
- جودة مرتفعة وحماية عالية .
- بدون غرفة ماكينة , سرعتين , سرعة VVVF , هيدروليكي .
- خيار جهاز الإنقاذ و UPS .
- خيارات الكرت الأم MIKROLIFT , ARKEL , HEDEFSAN .
- خيارات نظام القواطع (كونتكتور) LG , ABB , SCHNIDER .
- إمكانية الضبط حتى 32 موقف .
- ذاكرة لتسجيل الأخطاء بسعة استيعابية تصل حتى 60 خطأ بالوقت و التاريخ .





## KUMANDA PANOLARI CONTROL PANELS



HIZ KONTROLLÜ KURTARANLI PANO  
VVVF CONTROL PANEL



HIZ KONTROLLÜ KURTARANLI PANO  
VVVF CONTROL PANEL

**mikrolift**

**HEDEFSAN**

**ARKEL**

**LS**

**Fuji Electric**  
Innovating Energy Technology

REVIZYON SETİ / REVISION SET



MIKROLIFT ML70S

REVIZYON SETİ / REVISION SET



MIKROLIFT ML40P

REVIZYON SETİ / REVISION SET



ARKEL FX16



**AKSESUARLAR**  
**ACCESSORIES**

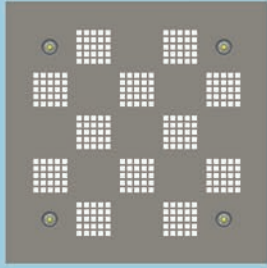

T-37

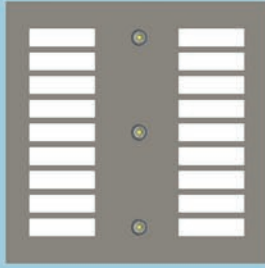

T-38

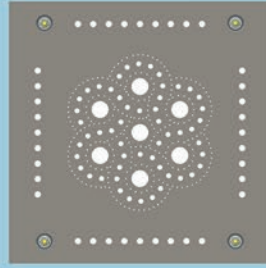

T-39

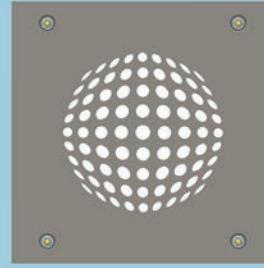

T-40



T-41

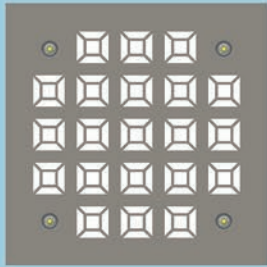

T-42

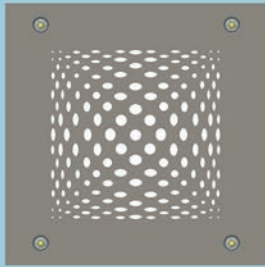

T-43

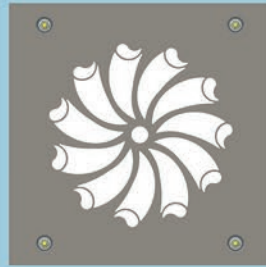

T-44

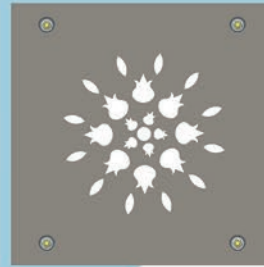

T-45

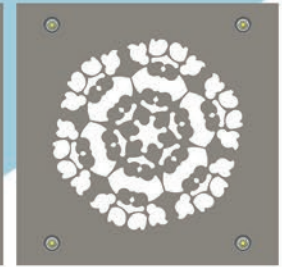

T-46



T-47

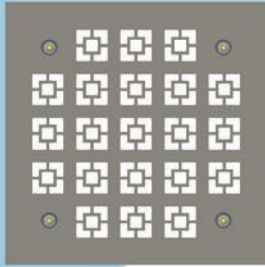

T-48



T-49



T-50



T-51

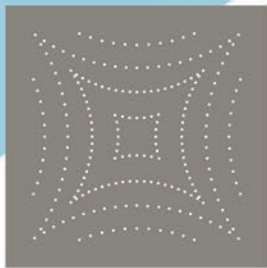

T-52



T-53



T-54



T-55



T-56



T-57



T-58



T-59

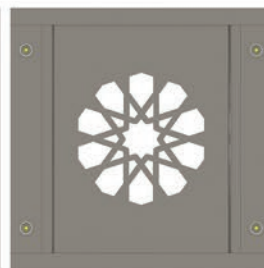

T-60



T-61

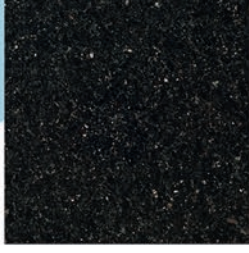

STAR GALAXY

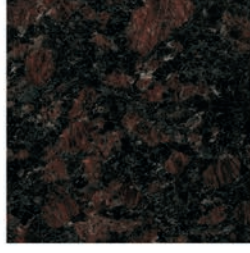

TAN BROWN



BLUE PEARL

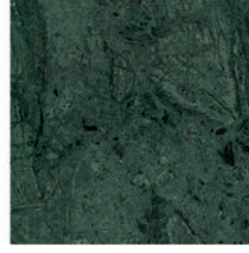

VERDE GUATEMALA

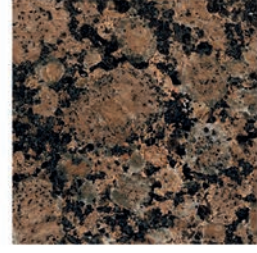

BALTIC BROWN

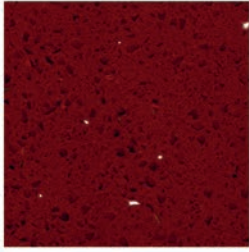

CIMSTONE RECIFE



BALMORAN RED

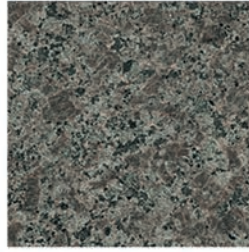

GİRESUN VİZOR



HISAR YAYLAK



CREMA LAL

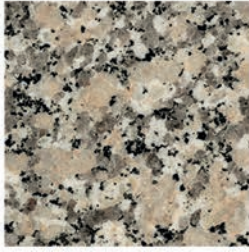

ROSA MİNHO

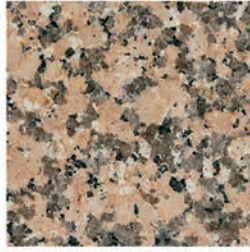

ROSA PORRİNHO

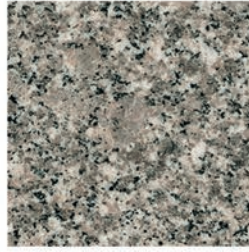

AKSARAY YAYLAK

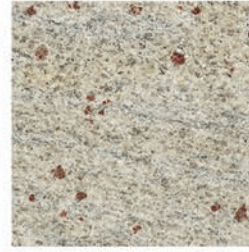

CASMIR WHITE



BIANCO SARDO



CIMSTONE SINES



CIMSTONE OASIS

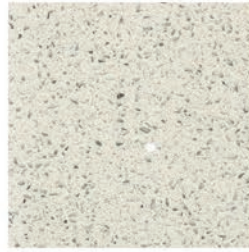

CIMSTONE LAPLAND



CIMSTONE ARCADIA



CIMSTONE MIRAT

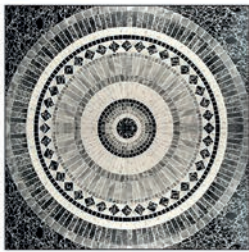

TB-17



TB-18



TB-19



TB-20

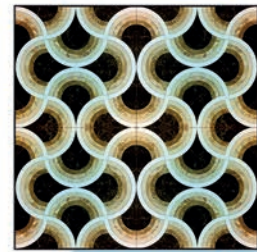

TB-21

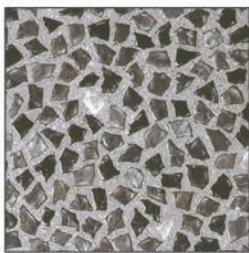

TB-06

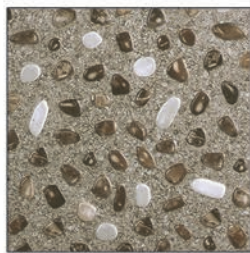

TB-07



TB-16



TB-09

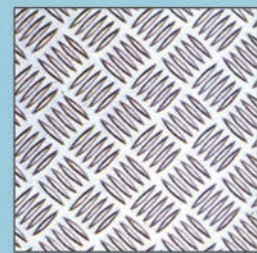

TB-10

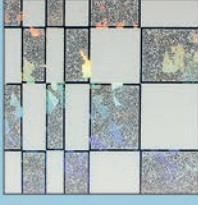

576

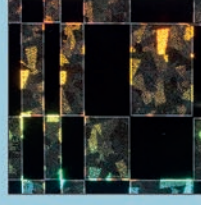

577

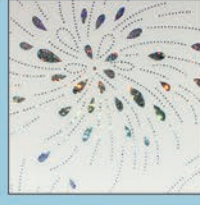

694

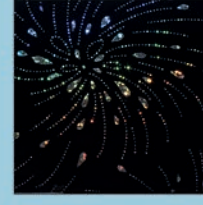

695

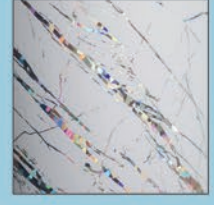

395

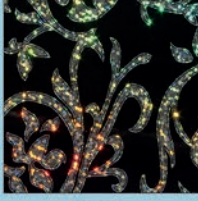

398

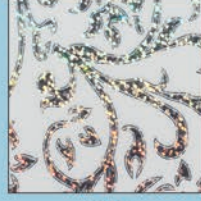

397

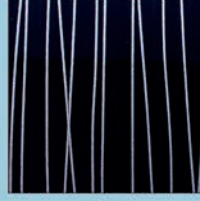

170



143



578



142



169

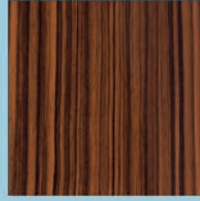

ABANOZ

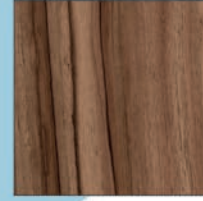

MİLANO



LATİN CEVİZ

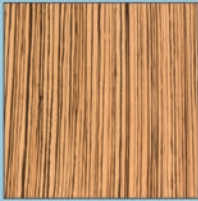

ZEYTİN

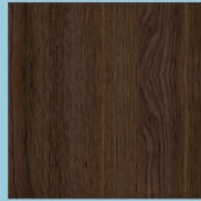

CHESTERFIELD MEŞE



ALMAN MEŞE



BUDAK MEŞE



RAFIA



SATİNE



AYNA

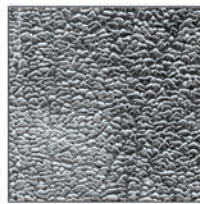

DERİ

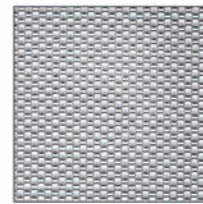

NOKTA

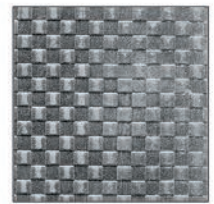

KARE



DM-05



DM-15

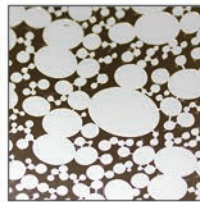

DM-16



DM-23



DM-MZK



DG-03



DG-07

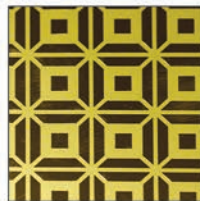

DG-10



DG-20



DG-26





DB-01



DB-02



DB-03



DB-04



DB-05



DB-06



DB-07



DB-08



DB-09



DB-10



DB-11



DB-12



DB-13



DB-14



DB-15



DT-01



DT-02



DT-03



DT-04



DT-05



**YEDEK PARÇA  
SPARE PARTS**

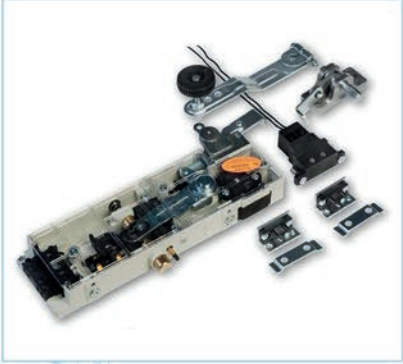



**YEDEK PARÇA**  
SPARE PARTS

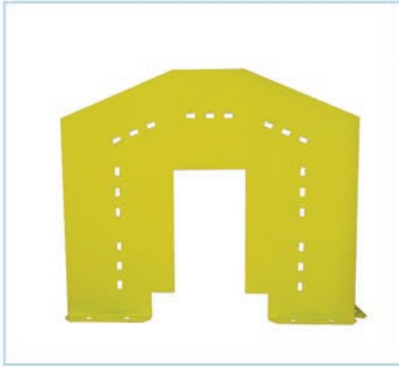
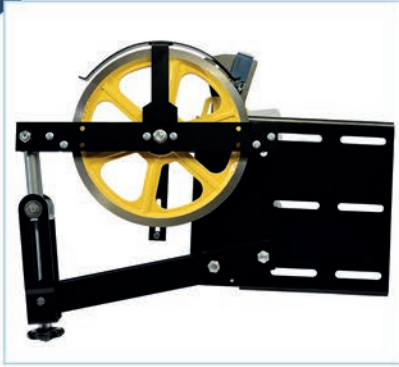



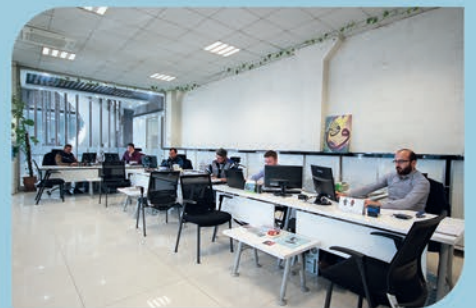



**AH & MET**<sup>®</sup>

**AH-MET ASANSÖR SANAYİ VE TİC. LTD. STİ.**

**A:** 3. Organize San. Bölgesi T.Ziyaeddin Akbulut Cad. No:16 Konya / TÜRKİYE

**T:** + 90 332 237 99 05

**F:** + 90 332 237 49 18

[www.ahmetasansor.com.tr](http://www.ahmetasansor.com.tr)

[bilgi@ahmetasansor.com.tr](mailto:bilgi@ahmetasansor.com.tr)